

## Model

Designation	<b>GTK55AT</b>	<b>200-240V/50Hz 1~</b>	Sales code:	<b>CDO00153</b>
-------------	----------------	-------------------------	-------------	-----------------

## Compressor design

Oil type	Polyolester	Refrigerant(s)	<b>R134a</b>
Oil viscosity	15cSt	Displacement	5,6cm <sup>3</sup> / 0,34cu.in
Oil quantity	156cm <sup>3</sup> / 5,3fl.oz	Compressors on pallet	100
Refr. charge - tech. limit			
Free gas volume comp.	1560cm <sup>3</sup> / 52,7fl.oz		
Weight	8,2kg / 18,1lbs		
Motor protection	external		
Winding resistance main	16Ω (at 25°C)		
Winding resistance aux	23Ω (at 25°C)		
Max. winding temp.	130°C / 266°F		
Max. discharge temp.	130°C / 266°F		



## General - Configurations with GTK55AT

	<b>Conf. 1</b>	<b>Conf. 2</b>
Motorconfiguration	RSCR	RSIR
Power supply (nominal)	200-240V/50Hz	200-240V/50Hz
Number of phases	1	1
Voltage range	170-264V	170-264V
Approvals	VDE, EAC	VDE, EAC
Starting torque	LST	LST
Note	- / -	

## Applications with GTK55AT

	<b>Conf. 1</b>	<b>Conf. 2</b>
Refrigerant	R134a	R134a
Application	LBP	LBP
System cooling	static	static
Hot gas defrost	- / -	- / -
Long interval pull down	- / -	- / -

## Electrical data - Configurations with GTK55AT

	<b>Conf. 1</b>	<b>Conf. 2</b>
Starting device type	PTC	PTC
Run capacitor	4μF	- / -
Start capacitor	- / -	- / -
LRA (locked rotor amps / 4s)	5,7A	5,7A
RLA (rated load amps / 1s)		
Cut in current	11,1A	11,1A
IP class	21	21

## Model

Designation

**GTK55AT**

200-240V/50Hz 1~

Sales code:

**CDO00153**

## Compressor dimensions

Housing	A Height	174mm / 6,85in
	B Height	167mm / 6,57in
	C Length shell	194mm / 7,64in
	D Length w. cover	238mm / 9,37in
	E Width	151mm / 5,94in

Connectors		Suction	Discharge	Process
		X	Y	Z
Diameter	[mm]	øi 6,1-6,2	øi 5,1-5,2	øo 5,92-6,08
(i:inside, o:outside)	[in]	øi 0,24-0,24	øi 0,2-0,2	øo 0,23-0,24
Material		copper	copper	copper
Horizontal angle	±2°	45°	13°	0°
Vertical angle	±2°	30°	40°	145°
Position l/h/w	[mm]	120/72/62	112/106/62	-140/136/70
	[in]	4,7/2,8/2,4	4,4/4,2/2,4	-5,5/5,4/2,8
Straight tube l.	[mm]	14	14	75
	[in]	0,5	0,5	3

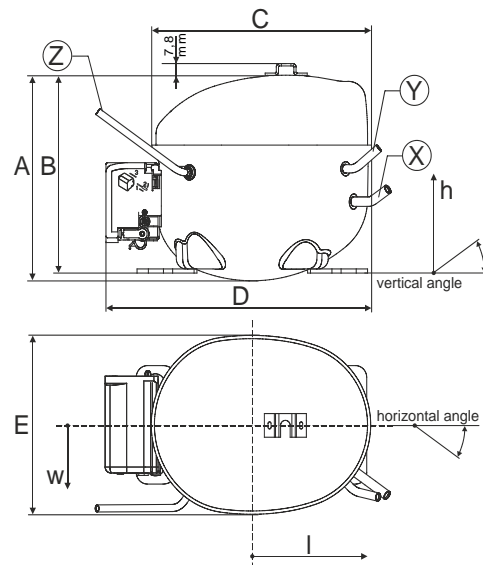

## Compressor fixation

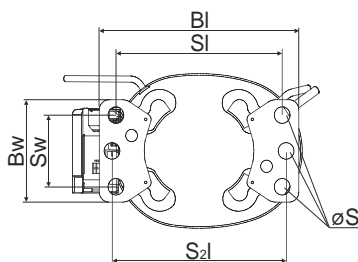

Baseplate	[mm]	[inch]
BI	204	8.03
BW	100	3.94
Small holes		
SI	170	6.7
SW	70	2.76
S2l	178	7
øS	ø 16	ø 0.63

## Bolt joint

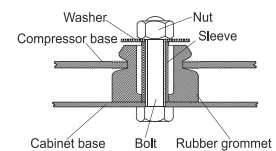

## Snap-on

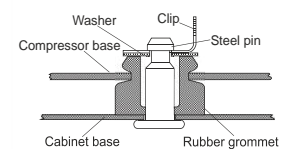

## Mounting accessories

'4ZN' with rubber grommet

'4ZN' with rubber grommet and sleeve for M6

Bolt joint kit

'4ZN' with Snap on kit

order code

772N

768N

4ZN + 118-1917 (18)

776N

## Application notes

Various options of housing are possible (dip-tray fixture) - please contact SECOP-Sales.

Various options of connectors are possible - please contact SECOP-Sales.

## Model

Designation **GTK55AT** **200-240V/50Hz** **Conf. 1** Sales code: **CDO00153**

## Configuration

Motorconfiguration **RSCR**  
 Power supply (nominal) **200-240V/50Hz 1~**  
 Refrigerant **R134a**  
 Application **LBP**  
 Voltage range **170-264V**  
 Starting torque **LST**  
 Approvals **VDE**  
**EAC**

## Electrical accessories / wiring diagram

**RSCR**

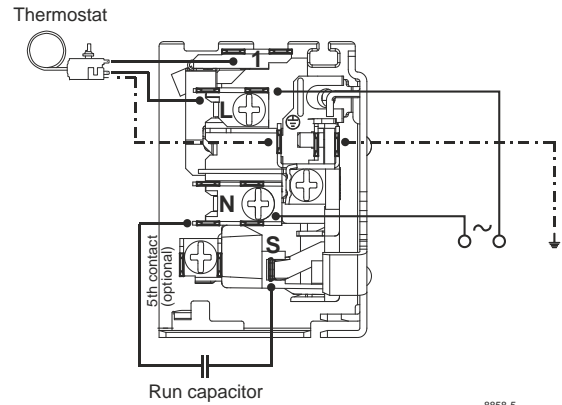
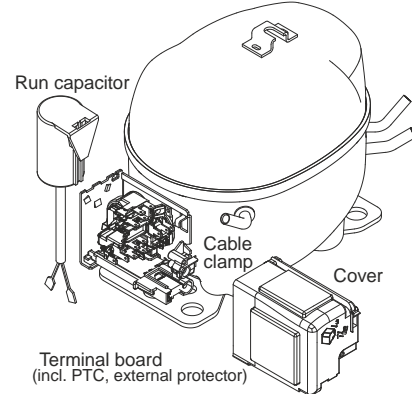

## Ambient temperatures / system cooling

Ambient temperature min.: **10°C / 50°F**  
 Ambient temperature max.: **43°C / 110°F**

System cooling (n/a: outside limits)			
T ambient	LBP	MBP	HBP
32°C / 90°F	static	n/a	n/a
38°C / 100°F	static	n/a	n/a
43°C / 110°F	static	n/a	n/a

## Operation pressure range

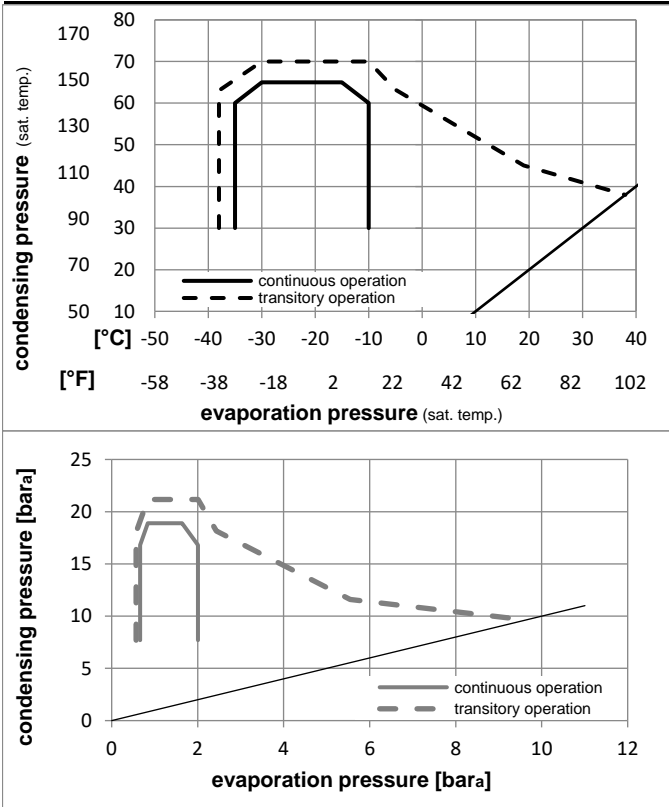

## Components

- terminal board (PTC,4.8mm,K100) **ZC FC**
- run capacitor (4μF, 4.8/6,3mm) **cap. 4μF**
- motor protector BDG AE 15 BU x **AE15BUX**
- cover + clamp + screws (Nr. 4ZN) **16168000**

## Alternative components

- terminal board (PTC,6.3mm,K100) **DC FC**
- run capacitor (4μF, 4.8/6,3mm) **cap. 4μF**
- motor protector BDG AE 15 BU x **AE15BUX**
- cover + clamp + screws (Nr. 4ZN) **16168000**

## Model

Designation **GTK55AT 200-240V/50Hz** Conf. 1 Sales code: **CDO00153**

## Optimization + standard conditions

200V/50Hz, RSCR, static, VDE, EAC

	Evaporating pressure (saturation temperature)				Condensing pressure (saturation temperature)						Power consumption			ASHRAE LBP
	pe	pc	RGT	Tliq	Cooling capacity			COP	EER	P1	I	Ref. mass flow		
	[°C]	[°F]	[°C]	[°F]	[W]	[Btu/h]	[kcal/h]	[W/W]	[Btu/Wh]	[kcal/Wh]	[W]	[A]	[kg/h]	
	-23,3	54,4	32,2	32,2	169,6	579	146,0	1,55	5,29	1,33	109,5	0,63	3,29	ASHRAE LBP
	-10	130	90	90										
	-25	55	32	55	124,1	424	106,8	1,19	4,06	1,02	104,3	0,61	2,97	cecomaf LBP
	-13	131	89,6	131										
	-35	40	20	40	83,2	284	71,6	1,08	3,69	0,93	76,9	0,53	1,82	EN12900 LBP
	-31	104	68	104										
	-23,3	48,9	4,44	48,9	140,2	479	120,6	1,29	4,40	1,11	108,8	0,63	3,70	ARI540 LBP
	-10	120	40	120										
	-23,3	40,6	32,2	32,2	186,8	638	160,8	1,77	6,03	1,52	105,7	0,62	3,63	AHAM LBP
	-10	105	90	90										
	-35	45	32	45	76,3	260	65,6	0,99	3,37	0,85	77,4	0,53	1,65	opt
	-31	113	89,6	113										

## Performance tables

200V/50Hz, RSCR, static, VDE, EAC

	pe	Cooling capacity			COP	EER	P1	I	m		
	[°C]	[°F]	[W]	[Btu/h]	[kcal/h]	[W/W]	[Btu/Wh]	[kcal/Wh]	[W]	[A]	[kg/h]
[°C / °F]	-35	-31	76,3	260	65,6	0,99	3,37	0,85	77,4	0,53	1,65
cond. pressure	-30	-22	110,4	377	95,0	1,23	4,20	1,06	89,8	0,56	2,39
pc= 45/113	-25	-13	148,9	509	128,2	1,44	4,93	1,24	103,2	0,61	3,23
return gas temp.	-23,3	-10	163,3	558	140,6	1,52	5,17	1,30	107,8	0,62	3,54
RGT= 32/90	-20	-4	193,5	661	166,5	1,66	5,65	1,42	116,9	0,66	4,20
liquid temp	-15	5	245,7	839	211,4	1,88	6,43	1,62	130,5	0,71	5,36
Tliq= 45/113	-10	14	306,9	1048	264,1	2,14	7,30	1,84	143,7	0,76	6,72
[°C / °F]	-35	-31	55,2	189	47,5	0,73	2,49	0,63	75,8	0,52	1,31
cond. pressure	-30	-22	88,2	301	75,9	0,99	3,37	0,85	89,3	0,56	2,10
pc= 55/131	-25	-13	124,1	424	106,8	1,19	4,06	1,02	104,3	0,61	2,97
return gas temp	-23,3	-10	137,2	469	118,1	1,25	4,27	1,08	109,7	0,63	3,28
RGT= 32/90	-20	-4	164,4	561	141,5	1,37	4,67	1,18	120,3	0,67	3,94
liquid temp	-15	5	210,7	720	181,3	1,54	5,26	1,33	136,8	0,73	5,07
Tliq= 55/131	-10	14	264,5	903	227,6	1,72	5,89	1,48	153,4	0,78	6,40

## Model

Designation **GTK55AT 200-240V/50Hz** Conf. 2 Sales code: **CDO00153**

## Configuration

Motorconfiguration **RSIR**  
 Power supply (nominal) **200-240V/50Hz 1~**  
 Refrigerant **R134a**  
 Application **LBP**  
 Voltage range **170-264V**  
 Starting torque **LST**  
 Approvals **VDE**  
**EAC**

## Electrical accessories / wiring diagram

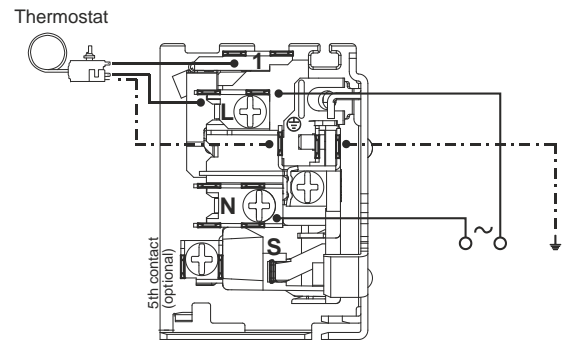
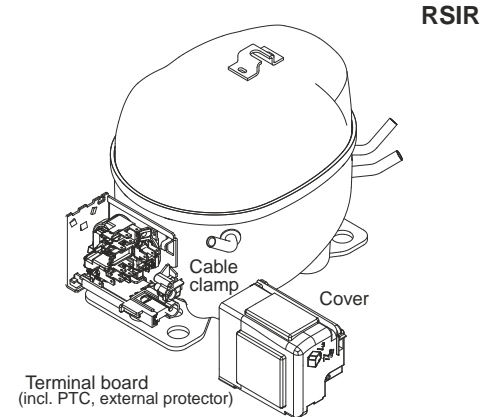

## Ambient temperatures / system cooling

Ambient temperature min.: **10°C / 50°F**  
 Ambient temperature max.: **43°C / 110°F**

System cooling (n/a: outside limits)			
T ambient	LBP	MBP	HBP
32°C / 90°F	static	n/a	n/a
38°C / 100°F	static	n/a	n/a
43°C / 110°F	static	n/a	n/a

## Operation pressure range

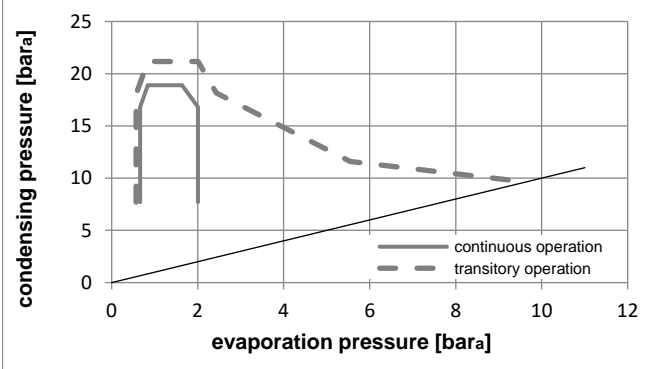
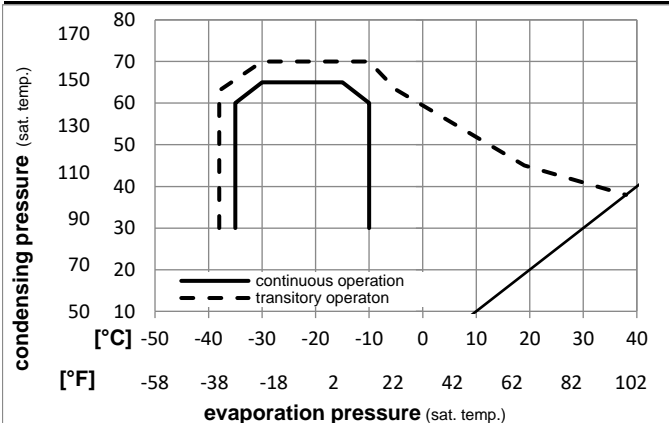

## Components

- terminal board (PTC,4.8mm,K100) **ZC FC**
- motor protector BDG AE 15 BU x **AE15BUX**
- cover + clamp + screws (Nr. 4ZN) **16168000**

## Alternative components

- terminal board (PTC,6.3mm,K100) **DC FC**
- motor protector BDG AE 15 BU x **AE15BUX**
- cover + clamp + screws (Nr. 4ZN) **16168000**

## Model

Designation **GTK55AT 200-240V/50Hz** Conf. 2 Sales code: **CDO00153**

## Optimization + standard conditions

200V/50Hz, RSIR, static, VDE, EAC

		Evaporating pressure (saturation temperature)				Condensing pressure (saturation temperature)						Power consumption			
		Return gas temp.				Liquid temp.						Current consumption		Ref. mass flow	
		Cooling capacity				COP		EER		P1	I	m			
	pe	pc	RGT	Tliq	[W]	[Btu/h]	[kcal/h]	[W/W]	[Btu/Wh]	[kcal/Wh]	[W]	[A]	[kg/h]		
[°C]	-23,3	54,4	32,2	32,2	169,6	579	146,0	1,48	5,05	1,27	114,8	0,88	3,29	ASHRAE LBP	
[°F]	-10	130	90	90											
[°C]	-25	55	32	55	124,1	424	106,8	1,13	3,87	0,98	109,4	0,87	2,97	cecomaf LBP	
[°F]	-13	131	89,6	131											
[°C]	-35	40	20	40	83,2	284	71,6	1,02	3,50	0,88	81,3	0,80	1,83	EN12900 LBP	
[°F]	-31	104	68	104											
[°C]	-23,3	48,9	4,44	48,9	140,1	479	120,6	1,23	4,19	1,06	114,1	0,88	3,70	ARI540 LBP	
[°F]	-10	120	40	120											
[°C]	-23,3	40,6	32,2	32,2	186,8	638	160,7	1,68	5,73	1,44	111,4	0,88	3,63	AHAM LBP	
[°F]	-10	105	90	90											
[°C]	-35	45	32	45	76,3	261	65,7	0,94	3,19	0,80	81,6	0,80	1,65	opt	
[°F]	-31	113	89,6	113											

## Performance tables

200V/50Hz, RSIR, static, VDE, EAC

	pe	Cooling capacity			COP		EER		P1	I	m
	[°C]	[°F]	[W]	[Btu/h]	[kcal/h]	[W/W]	[Btu/Wh]	[kcal/Wh]	[W]	[A]	[kg/h]
[°C / °F]	-35	-31	76,3	261	65,7	0,94	3,19	0,80	81,6	0,80	1,65
cond. pressure	-30	-22	110,4	377	95,0	1,17	3,99	1,01	94,5	0,83	2,39
pc= 45/113	-25	-13	148,9	509	128,2	1,37	4,69	1,18	108,4	0,87	3,23
return gas temp.	-23,3	-10	163,3	558	140,5	1,44	4,93	1,24	113,2	0,88	3,54
RGT= 32/90	-20	-4	193,4	661	166,5	1,58	5,38	1,36	122,7	0,91	4,20
liquid temp	-15	5	245,5	838	211,3	1,79	6,12	1,54	137,1	0,95	5,35
Tliq= 45/113	-10	14	306,6	1047	263,9	2,03	6,94	1,75	150,9	0,98	6,71
[°C / °F]	-35	-31	55,2	188	47,5	0,69	2,36	0,59	79,9	0,80	1,31
cond. pressure	-30	-22	88,2	301	75,9	0,94	3,21	0,81	93,8	0,83	2,10
pc= 55/131	-25	-13	124,1	424	106,8	1,13	3,87	0,98	109,4	0,87	2,97
return gas temp	-23,3	-10	137,2	469	118,1	1,19	4,08	1,03	114,9	0,88	3,28
RGT= 32/90	-20	-4	164,3	561	141,4	1,30	4,45	1,12	126,1	0,91	3,94
liquid temp	-15	5	210,6	719	181,2	1,47	5,01	1,26	143,4	0,96	5,07
Tliq= 55/131	-10	14	264,2	902	227,4	1,64	5,61	1,41	160,9	1,00	6,39